

Feature rich **J+J** multi-voltage smart electric actuator with LED status light and function conversion kits.

J3C-S20



Overview

The J3C-S20 multi-voltage smart electric valve actuator from the European electric actuator manufacturer J+J offers an impressive list of standard features that include 24-240V multi-voltage capability, protection against damage from over-torque or condensation, safety features, the ability to have its standard on-off function changed with user friendly plug & play conversion kits, and a highly visible LED light to offer users continual actuator operational status feedback.

The innovation in the J3C S Type of 24-240V AC or DC multi-voltage capability with automatic voltage sensing has a patent pending.

The multi-colour LED light remains constantly lit if the actuator is functional and able to respond to remote commands - if it is unable to, the LED flashes. The sequence of the flashes indicates the possible reason. This user friendly continuous visual status feedback LED gives the user at-a-glance actuator status, and assists in fault diagnosis.

For 12V applications, a small adapter PCB can be installed which restricts the supply voltage to 12V AC or DC only.

J3C-S20 Electric Actuator Specifications

Voltage range - automatic sensing	24V - 220V AC (1ph) or DC
Operating time (0-90° no load)	10 seconds
Maximum break torque	25 Nm (221 lb.ins)
Maximum operating torque (run/ reseat)	20 Nm (177 lb.ins)
Duty rating	75%
IP Rating (IEC 60529)	IP67
Working angle Standard (on request)	90° (180° or 270° options)
Mounting ISO:5211 x DIN 3337	F03, F04 & F05 x 14 (std)
Motor switches	2 x SPDT micro switches
End of travel confirmation (volt free)	2 x SPDT micro switches
Heater	3.5 W
Ambient temperature range	-20° to +70°C (-4 to +158°F)
Electrical connecting plugs	EN175301-803
Weight	1.8 kg

J3C-S20 Consumption

Figures	See page 5
Motor	24VDC 1ph, Class B, S4 service

J3C-S Main features

IP67 Weatherproof, UV protected, corrosion resistant plastic housing.

LED light gives user continuous visual actuator status feedback - if the LED is flashing, there's a problem!

Many protective features as standard - such as over-torque and anti-condensation.

Multi-voltage capable, automatically sensed

Very user friendly and easy to install - all the electrical connections are external.

Unique plug & play function conversion kits create FAILSAFE & MODULATING function from a standard on-off electric actuator.

Digital potentiometer feedback option

How this J3C-S electric 1/4 turn valve actuator works (on-off)

Electrically operated valves are driven by an electric actuator containing a motor and gearbox. On receipt of a continuous voltage signal (not pulse) the motor runs and, via a gearbox in the electric actuator, rotates the valve stem. The motor stops at the desired position (usually 0° or 90°) by an internal cam striking a micro-switch. The valve actuator remains in this position, with the voltage still applied continuously, until switched and a continuous voltage reversing signal (not pulse) is applied, which runs the motor in the opposite direction, reversing the rotation until a separate internal cam strikes a separate micro-switch and stop the motor. The J3C-S actuator is designed to have the external power continuously applied, and power must not be switched off when end of travel is achieved.

MAIN FEATURES J3C SERIES OF ELECTRIC ACTUATOR

IP67 Weatherproof, UV protected, corrosion resistant Polyamide housing.

IP67 allows the J3C electric actuator to be submerged, the international standard IEC60529 states: *Test duration is 30 minutes. Ingress of water in harmful quantity shall not be possible when the enclosure is immersed in water under defined conditions of pressure and time (up to 1 m of submersion). The lowest point of enclosures with a height less than 850 mm is located 1000 mm below the surface of the water, the highest point of enclosures with a height equal to or greater than 850 mm is located 150 mm below the surface of the water.*

The J3C is therefore fully weatherproof.

Multi-colour LED light gives user continuous visual actuator status feedback - if the LED is flashing, there's a problem!

The multi-colour LED light provides a continuous highly visible indication of the J3C-S Type electric actuator's operational status. If all is well, the LED is solidly lit. If it is blinking there is a problem and the J3C-S will not respond to remote commands - the sequence gives an indication of the likely cause.

Many protective features as standard - such as over-torque and anti-condensation.

Over-torque protection is electronic, the J3C Series actuators constantly measures the current being drawn and compares it with pre-set parameters, if the current draw exceeds the parameter, the power is cut preventing mechanical damage to the actuator. An internal thermostatic heater, energised from the external power supplied to the power DIN connector, ensures the J3C's internal temperature remains above that at which condensation could form.

Multi-voltage capable, automatically sensed

The J3C S Type valve actuator automatically senses the external power being applied and can accept any external voltage between 24V and 220V AC or DC .
Note: Patent pending for the automatic sensing innovation.

Very user friendly and easy to install - all electrical connections are external.

J3C Actuators have mounting options according to ISO5211 with a female star output drive. Electrical connections are made using external DIN plugs supplied with the J3C Series actuators which eliminate the need to remove the actuators cover to connect The J3C electrically.

Unique plug & play function conversion kits create **FAILSAFE & MODULATING** function from a standard on-off electric actuator.

The J3C Series of electric actuators can have their standard on-off functionality changed by the installing of very user friendly plug and play conversion kits. See later in this document for more details

Manufactured in the EU by J+J

The J3C electric valve actuators are designed and manufactured by J+J in Spain. J+J have been innovating, designing and manufacturing electric actuators for over 25 years and the J+J valve actuators are sold in more than 70 countries.

J3CS ON - OFF ELECTRIC ACTUATOR

Power open, power close, stays put on loss of external power.

Options:

It is possible to change the J3CS actuator's function by installing user friendly plug and play function conversion kits. These will provide the following alternative functions:

Failsafe J3CS Actuator

J3CS fails to pre-set position using our BSR (Battery 'Spring Return' system which creates an alternate power supply should the external power fail.

Modulating J3CS Actuator

Movement of the J3CS actuator is proportional to an input control signal, typically 4-20mA or 0-10V, by installing our DPS (Digital Positioning System) user friendly plug and play kit. There are options for how the J3CS modulating reacts to loss of the control signal, but it will stay put on loss of external power.

Configuration options:

- 1) Closes on loss of control signal
- 2) Opens on loss of control signal
- 3) Stays put on loss of control signal

Failsafe Modulating J3CS Actuator

Failsafe modulating by installing the J+J BSR (Battery 'Spring Return') plug and play kit, operates functionally as a modulating electric actuator as described above, but will fail as per the DPS setting on loss of external power, as follows:

Configuration options:

- 1) Closes on loss of control signal, or on loss of power
- 2) Opens on loss of control signal, or on loss of power
- 3) Stays put on loss of control signal

Installing J+J Plug & Play function conversion kits

Failsafe and/or modulating function is quick and easy to achieve in the J3CS smart electric actuator by the fitting of the user friendly failsafe and/or modulating plug & play function conversion kits to the standard on-off J3CS smart valve actuator. When actuated valves are ordered with failsafe, modulating or failsafe modulating function, J+J install and test the plug and play function conversion kits. They can however be easily retro-fitted to J3CS smart electric actuators should the on-off function requirement (supplied as standard function), change.

Electrical Connection - Wiring of DIN Plugs

In J+J electric actuators all electrical connections are made externally using the external DIN plugs supplied with the actuator. There is no need to remove the valve actuator's cover to connect electrically. There are no terminals internally to connect to.

J3CS ON-OFF & FAILSAFE WIRING (Same connection for either)

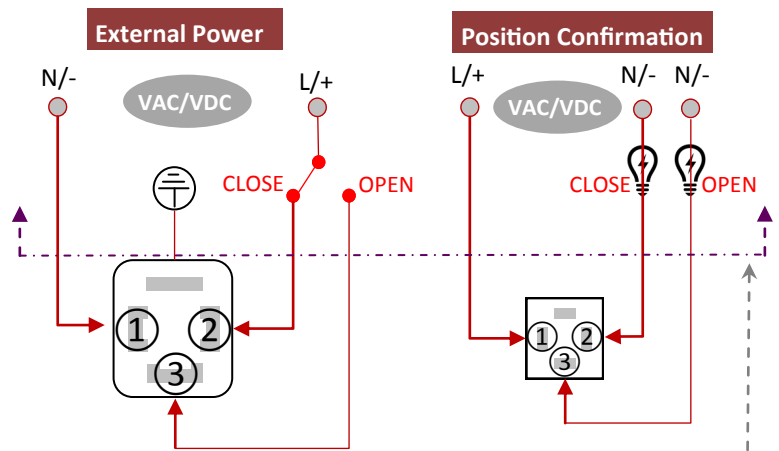

Note: Above line above is customer supplied

Optional Plug & Play Function Conversion Kits

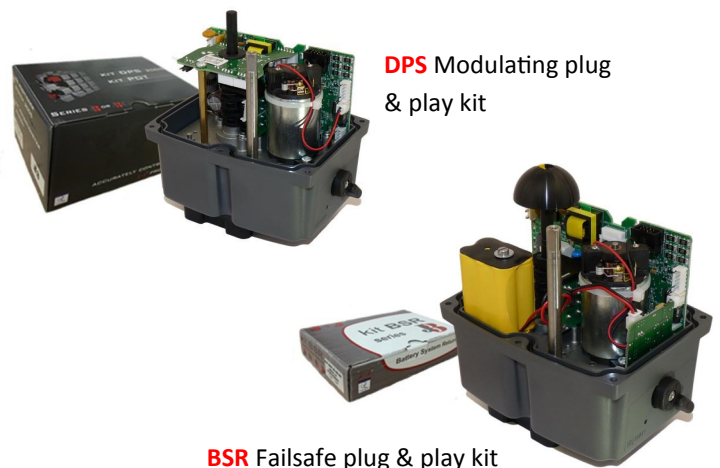

DPS Modulating plug & play kit

BSR Failsafe plug & play kit

Available with actuator function: **POWER OPEN - POWER CLOSE** FAILSAFE MODULATING FAILSAFE MODULATING

J3C-S20 Dimensions

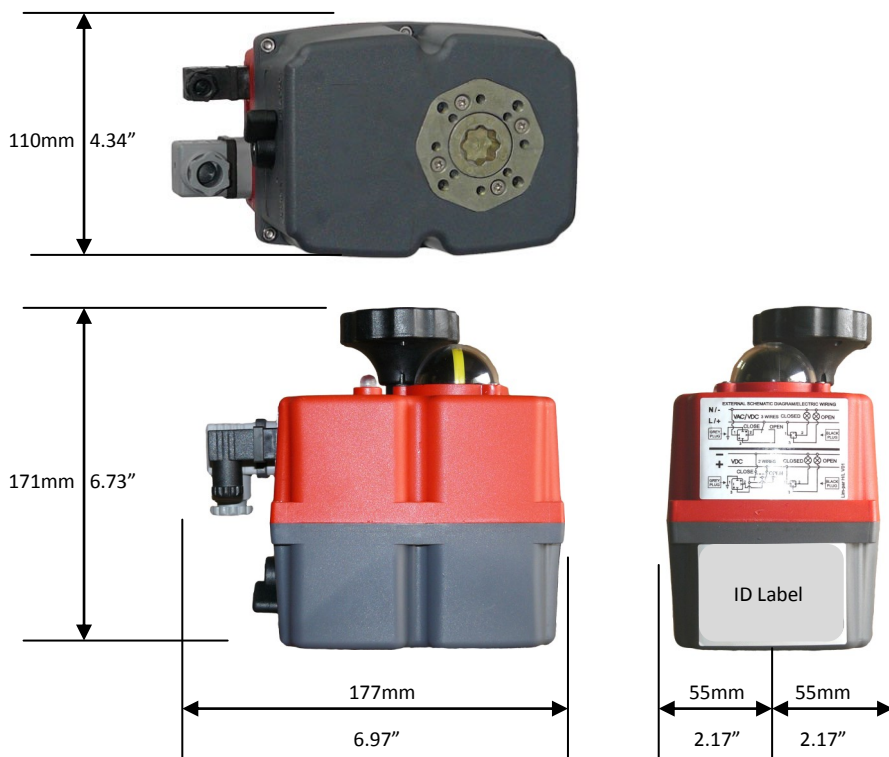

ISO5211 Mounting	F03	F04	F05
Mounting PCD (mm)	36	42	50
Star Drive (Standard)	14mm		
Star Drive (Optional)	9mm or 11mm		

J3C S20 Materials of construction:	
Housing	Anti-corrosive Polyamide
Fasteners	Stainless steel
Gears	Polyamide (speed reducing) & steel (load bearing)
Shaft	Stainless steel
Output drive	Zamac
Position indicator	Clear Polyamide

J3C Optional Plug & Play Function Conversion Kits:

Failsafe and/or modulating function is quick and easy to achieve in the J3C smart electric actuator by the fitting of the user friendly failsafe and/or modulating plug & play function conversion kits to the standard on-off J3C smart valve actuator.

The J3C S Series **failsafe electric actuator** is created by installing easy to fit user friendly **Battery 'Spring Return' (BSR)** failsafe function conversion kit. The J3C BSR failsafe actuator can be set to fail open or fail closed.

The BSR uses an internal trickle charged industrial rechargeable battery to provide an alternate power source to drive the J3CS failsafe actuator to its pre-set 'safe' position if external power is lost.

The J3C S Series **modulating electric actuator** is created by installing the plug and play **Digital Positioning System (DPS)** modulating function conversion kit. The J3C DPS modulating actuator can be controlled by either a 4-20mA or 0-10V control signal and provides feedback as standard.

The DPS provides accurate proportional control utilizing the latest digital magnetic position sensing technology and covers the popular I/O control signals of 4-20mA and 0-10VDC. The DPS is self-calibrating.

When actuated valves are ordered with failsafe, modulating or failsafe modulating function, J+J pre-install and test the plug and play function conversion kits. They can however easily be retro-fitted to J3C smart electric actuators should the on-off function requirement, supplied as standard, change.

Fitting both plug and plug function conversion kits quickly and easily creates failsafe modulating functionality to J3CS electric actuators.

BSR plug & play kit for **J3C** creates a **FAILSAFE** ELECTRIC ACTUATOR





















































DPS plug & play kit for **J3C** creates a **MODULATING** ELECTRIC ACTUATOR

Available with actuator function: POWER OPEN - POWER CLOSE FAILSAFE MODULATING FAILSAFE MODULATING
J3CS Consumption

Supply Voltage	No load		At maximum operational torque 20Nm		At maximum break torque 25Nm	
	Amps	Watts	Amps	Watts	Amps	Watts
24V DC	0.40	10.3	0.80	19.30	0.80	20.30
48V DC	0.20	10.20	0.40	18.00	0.40	18.50
110V DC	0.10	7.50	0.10	13.30	0.10	14.30
24V AC	0.60	14.20	1.10	25.80	1.20	27.60
48V AC	0.40	18.40	0.70	31.30	0.70	32.20
110V AC	0.20	16.50	0.30	27.60	0.30	27.60
240V AC	0.10	22.20	0.20	37.50	0.20	39.60

Note: To allow for inrush, and motor wear, MULTIPLY maximum consumption by 3 for sizing power supplies.

J3CS Multi-colour LED status light:

Actuator operational status	LED Colour
No power being supplied	Off 
Power being supplied to actuator	Fully OPEN = Solid  Fully CLOSED = Solid 
Actuator moving between open and closed	Open to close = flash     Close to open = flash    
Actuator in MANUAL mode	Flash      
Torque limiter activated	If closing when activated = flash     if opening = flash    
BSR failsafe system activated (for max 3 mins)	If configured Fail Close = flash     if Fail Open = flash    
BSR Battery needs charging warning	Flash          
Actuator with DPS(2015) positioner	Opening = flash     Closing = flash     Stationary = 

J3CS BSR Failsafe System Specifications:

Detail	J3C-S20
Initial charge time BEFORE being placed into operational service	28 Hours
Maximum movements with fully charged battery	5
Minimum recharge time after each movement	8 mins
Battery consumption when power drawn from battery	6.2W
Nominal battery capacity	1000mA
Current drawn when operating by battery	2.4mA
Charge consumption	36mA/h
System to change between fail close & fail open	PCB jumper

J3CS DPS:2015 Digital Positioner Specifications:

Detail	J3C-S Series
Input/ Output options	0-10V, 1-10V, 0-20mA, 4-20mA
Output shaft feedback system	Magnetic, digital
Accuracy, linearity, hysteresis, repeatability	Better than 2%